

GW8245/46/47/48

4th Gen. 16-bit Low Power Temperature and Relative Humidity Sensor

1 Description

The GW8245/46/47/48 is a new generation of single-chip integrated temperature and relative humidity sensor, which integrates high-sensitivity MEMS humidity-sensitive components on silicon-based CMOS wafers, thereby reducing signal transmission interference, reducing device area and improving product reliability. The GW8245/46/47/48 uses I²C protocol to communicate with the host. Internal Cyclic Redundancy Check (CRC) generator calculates 8-bit checksum and sends to host after each of 16-bit data. Each GW824x series has a unique 32-bit serial number.

GW8245/46/47/48 has a temperature measurement range of -40°C ~ +125°C. The test accuracy in the range of -40°C ~ +125°C is ±0.2°C for GW8245/46/47, ±0.1°C for GW8248. Relative humidity range is 0 ~ 100% with accuracy of ±1.8%RH for GW8245/46/47, ±1.0%RH for GW8248. The GW8245/46/47 has a heater inside of package, which can be used for anti-dew.

The GW8245/46/47/48 can be used to process temperature and relative humidity monitoring and control in various applications. The 4-pin dual-flat, no-leads package is suitable for surface mount technology (SMT).

2 Features

- I²C protocol compatible, up to 1MHz, with 2 slave addresses
- Wide supply voltage range (1.6V ~ 5.5V)
- Average current: 0.4µA (1Hz measurement rate)
- Idle current: 0.1µA
- DFN4 package (1.5mm x 1.5mm x 0.54mm)
- Typical accuracy, GW8245/46/47
 - Relative humidity: ±1.8%RH
 - Temperature: ±0.2°C
- Typical accuracy, GW8248
 - Relative humidity: ±1.0%RH
 - Temperature: ±0.1°C
- Resolution
 - Relative humidity: 0.01%RH
 - Temperature: 0.01°C

- Power controllable heater
- NIST traceability
- Support reflow soldering

3 Typical Applications

- Automotive cabin
- Industrial control
- Smart home
- Consumer electronics
- Medical devices

4 Basic Application Diagram

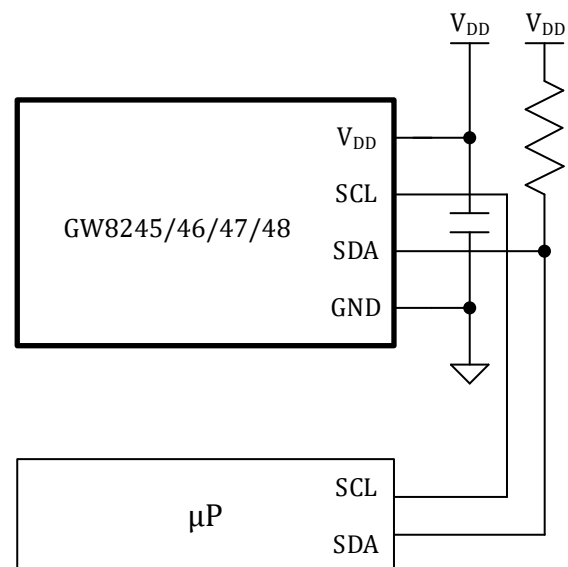

5 Ordering Information

Device name	Package	Remark
GW8245ENGAR	1.5 mm x 1.5 mm, 0.8 mm pitch, DFN-4	Ordinary precision Slave address 0x44
GW8246ENGAR	1.5 mm x 1.5 mm, 0.8 mm pitch, DFN-4	Ordinary precision Slave address 0x45
GW8247ENGAR	1.5 mm x 1.5 mm, 0.8 mm pitch, DFN-4	High Precision Slave address 0x45
GW8248ENGAR	1.5 mm x 1.5 mm, 0.8 mm pitch, DFN-4	Highest Precision Slave address 0x45

Table of Contents

1	Description.....	1	9.1	Overview.....	7
2	Features.....	1	9.2	Functional Block Diagram.....	8
3	Typical Applications.....	1	9.3	I ² C Communication.....	8
4	Basic Application Diagram.....	1	9.4	Command.....	9
5	Ordering Information.....	1	9.5	Measurement Conversion.....	10
6	Revision History.....	2	9.6	Serial Number.....	10
7	Pin Configuration and Function.....	3	9.7	Reset & Abort.....	10
8	Specifications.....	3	9.8	Heater.....	10
8.1	Absolute Maximum Ratings.....	3	10	Package Information.....	12
8.2	Recommended Operating Conditions.....	3	10.1	DFN-4 Package Outline (1.5mm X 1.5mm).....	12
8.3	Electrical Characteristics.....	4	10.2	Land Pattern.....	13
9	Functional Description.....	7	10.3	Tape and Reel Information.....	13

6 Revision History

Version	Date	Description
0.1	April 9, 2025	Initial release
1.0	April 15, 2025	Changed P/N
1.1	April 24, 2025	Fixed: Typo. on Ordering Information, humidity resp. time spec., Reset & Abort
2.0	February 19, 2026	Added Land Pattern and Tape & Reel information
2.1	April 14, 2026	Revised RH response time

7 Pin Configuration and Function

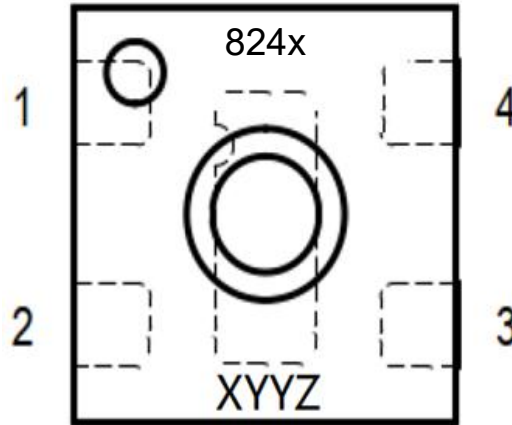

Top View

Table 1 Pin Functions

Pin Name	No.	Type	Description
SDA	1	IO	I ² C serial data
SCL	2	I	I ² C serial clock
VDD	3	P	Power supply
GND	4	G	Ground

8 Specifications

8.1 Absolute Maximum Ratings

Table 2 Absolute Maximum Ratings

Parameter	Symbol	Min	Max	Unit
Supply Voltage	V _{DD}	-0.5	6	V
Operating Temperature Range	T _{OP}	-40	125	°C
Storage Temperature Range	T _{STG}	-40	150	°C
ESD HBM (Human body model), per ANSI/ESDA/JEDEC JS001	ESD _{HBM}	-3,500	3,500	V
Latch up, per JESD78 Class IA	LATCHUP	-200	200	mA

Note: Stresses beyond those listed under Absolute Maximum Ratings may cause permanent damage to the device, sensor performance can't be guaranteed under these extreme conditions.

8.2 Recommended Operating Conditions

Table 3 Electrostatic Protection Capability

Parameter	Symbol	MIN	TYP	MAX	UNIT
Supply Voltage ⁽¹⁾	V _{DD}	1.6 ⁽²⁾	3.3	5.5	V
Ambient Temperature	T _A	-40		125	°C

1. I²C communication signals must not exceed the V_{DD} voltage level.

2. For optimal analog device performance, it is recommended that V_{DD} be equal to or greater than 1.6V.

8.3 Electrical Characteristics

Unless stated otherwise, all values are applicable within the complete range of operational conditions. Typical values are given for $T_A = +25\text{ }^\circ\text{C}$, $V_{DD} = 3.3\text{V}$

Table 4 Electrical Characteristics

Parameter	Symbol	Conditions	MIN	TYP	MAX	UNIT
Relative Humidity Sensor						
Accuracy, GW8245/46/47	$ACC_{RH,GW8245/46/47}$		-	± 1.8	-	%RH
Accuracy, GW8248	$ACC_{RH,GW8248}$			± 1.0		%RH
High Repeatability	REP_{HIGH}			0.08		%RH
Medium Repeatability	REP_{MID}			0.15		%RH
Low Repeatability	REP_{LOW}			0.25		%RH
Resolution	RES_{HUM}		-	0.01	-	%RH
Hysteresis	HYS_{HUM}	@25 °C	-	± 0.8	-	%RH
Measurement Range	R_{HUM}		0	-	100	%RH
Response Time	$RESP_{HUM}$	1τ , 63% settling time	-	4	-	s
Long-Term Drift	$DRIFT_{HUM}$		-	<0.3	-	%RH/y
Temperature Sensor						
Accuracy, GW8245/46/47	$ACC_{TEMP,GW8245/46/47}$		-	± 0.2	-	°C
Accuracy, GW8248	$ACC_{TEMP,GW8248}$		-	± 0.1	-	°C
High Repeatability	REP_{HIGH}			0.04		°C
Medium Repeatability	REP_{MID}			0.07		°C
Low Repeatability	REP_{LOW}			0.1		°C
Resolution	RES_{TEMP}		-	0.01	-	°C
Measurement Range	R_{TEMP}		-40		125	°C
Response Time	$RESP_{TEMP}$	1τ , 63% settling time	-	2	-	s
Long-Term Drift	$DRIFT_{LONG}$			<0.03		°C/y
Power On Reset						
Power on Reset Lockout voltage	V_{POR}		0.8	-	1.0	V
DC Characteristics						
Input High Level	V_{IH}		$0.7 \cdot V_{DD}$		V_{DD}	V
Input Low Level	V_{IL}		0		$0.3 \cdot V_{DD}$	V
Pull Up Resistor	R_{PU}		390	-	-	Ω

Parameter	Symbol	Conditions	MIN	TYP	MAX	UNIT
BUS Load Capacitance	$C_{BUS, LOAD}$		-	-	400	μF
Supply Current	I_{DD}	Idle State	0.08	0.1	0.15	μA
		Measurement		300	500	μA
		Aver. High Repeatability	-	2	-	μA
		Aver. Med Repeatability	-	1.2	-	μA
		Aver. Low Repeatability	-	0.4	-	μA

Sensor System Timing

Power Up Time	t_{PU}	After hard reset, $V_{DD} > V_{POR}$	-	0.3	1	ms
Soft Reset Time	t_{SR}	After soft reset	-	-	1	ms
Measurement Time	$t_{MEAS, HIGH}$	High Repeatability	-	6.9	8.3	ms
	$t_{MEAS, MED}$	Med Repeatability	-	3.7	4.5	ms
	$t_{MEAS, LOW}$	Low Repeatability	-	1.3	1.6	ms
Heater-on Time	t_{HEATER}	Long Pulse	0.9	1	1.1	s
		Short Pulse	0.9	1	1.1	s

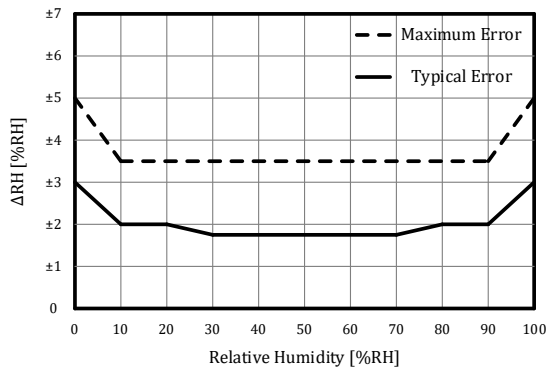

Figure 1 GW8245/46 Relative Humidity Accuracy at 25°C

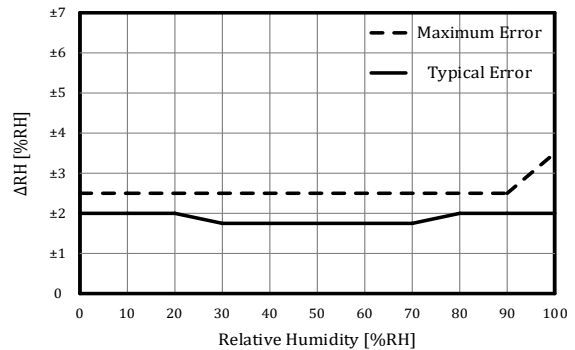

Figure 2 GW8247 Relative Humidity Accuracy at 25°C

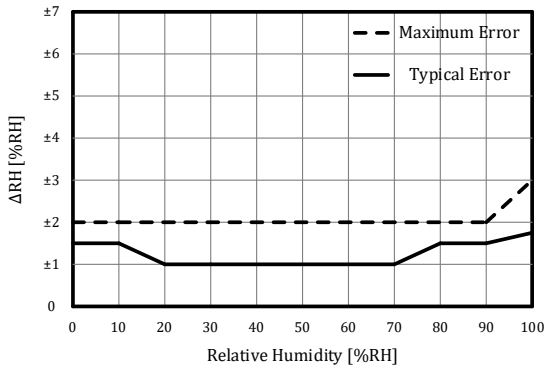

Figure 3 GW8248 Relative Humidity Accuracy at 25°C

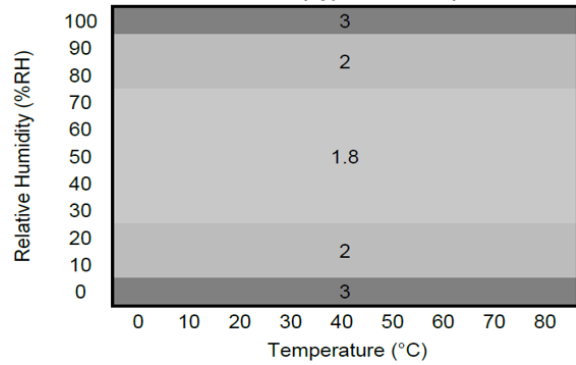

Figure 4 GW8245/46 Typical Relative Humidity Accuracy over Humidity and Temperature

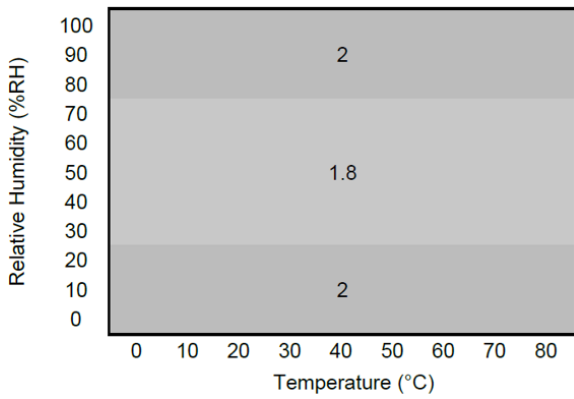

Figure 5 GW8247 Typical Relative Humidity Accuracy over Humidity and Temperature

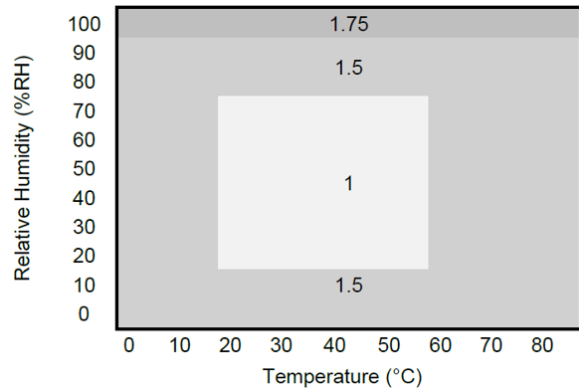

Figure 6 GW8248 Typical Relative Humidity Accuracy over Humidity and Temperature

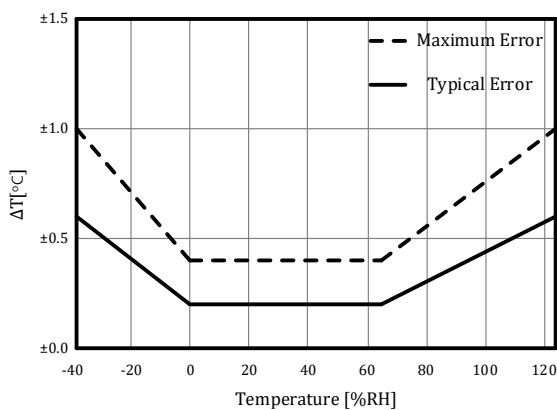

Figure 7 GW8245/46 Temperature Accuracy

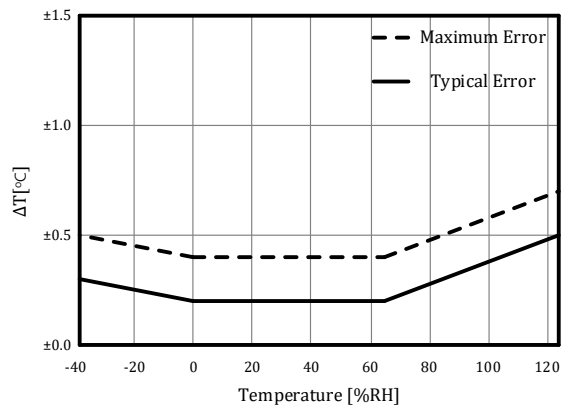

Figure 8 GW8247 Temperature Accuracy

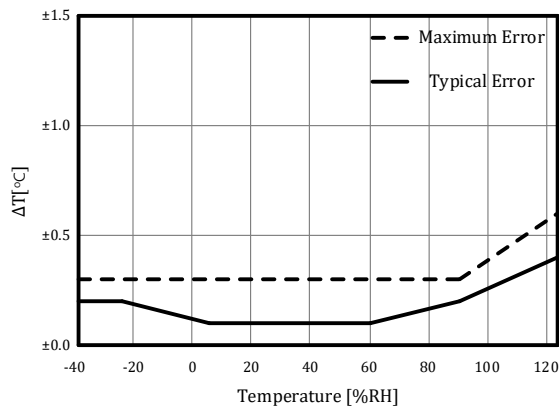

Figure 9 GW8248 Temperature Accuracy

9 Functional Description

9.1 Overview

The GW8245/46/47/48 is a new generation of single-chip integrated temperature and relative humidity sensor, which integrates high-sensitivity MEMS humidity-sensitive components on silicon-based CMOS wafers, thereby reducing signal transmission interference, reducing device area and improving product reliability. The GW8245/46/47/48 uses I²C protocol to communicate with the host. Internal Cyclic Redundancy Check (CRC) generator calculates 8-bit checksum and sends to host after each of 16-bit data. Each GW824x has a unique 32-bit serial number.

It has a temperature measurement range of -40°C ~ +125°C. The test accuracy in the range of -40°C ~ +125°C is ±0.2°C for GW8245/46/47, ±0.1°C for GW8248. Relative humidity range is 0 ~ 100% with accuracy of ±1.8%RH for GW8245/46/47, ±1.0%RH for GW8248. The GW8245/46/47/48 has a heater inside of package, which can be used for anti-dew. GW8245/46/47/48 can be used to process temperature and relative humidity monitoring and control in various applications. The 4-pin dual-flat, no-leads package is suitable for surface mount technology (SMT).

9.2 Functional Block Diagram

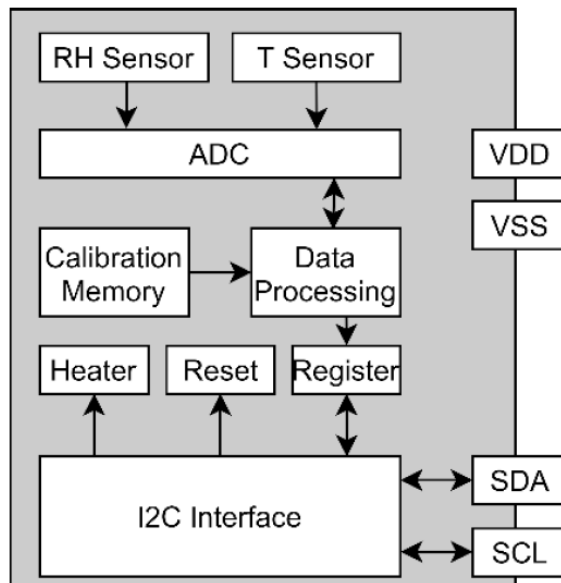

Figure 10 Functional Block Diagram

9.3 I²C Communication

Supported I²C modes are standard, fast mode, and fast mode plus. Data is transferred into multiples of 16-bit words. To increase reliability of data transfer, I²C glitch protection is offered in form of 8-bit checksum (cyclic redundancy check = CRC). All transfers must begin with a start condition (S) and terminate with a stop condition (P). To finish a read transfer, send not acknowledge (NACK) and stop condition (P). Addressing a specific slave device is done by sending its 7-bit I²C address followed by an eighth bit, denoting the communication direction: “zero” indicates transmission to the slave, i.e. “write”, a “one” indicates a “read” request. The sensor does not support clock-stretching. In case the sensor receives a read header and if the conversion remains unfinished, it will return a NACK. Measurement data can only be received once and will be deleted from the sensor’s register after the first acknowledged I²C read header.

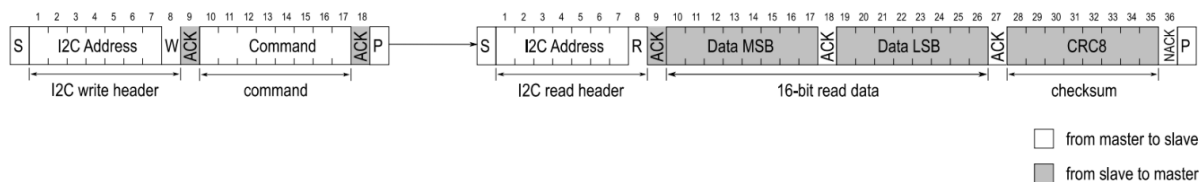

Figure 11 Typical I²C Communication Diagram

The figure is the typical I²C communication for the GW8245/46/47/48 series. First, a write header is sent to the I²C slave, followed by a command, for example “measure RH&T with highest precision”. After the measurement is finished, the read request directed to this I²C slave will be acknowledged and transmission of data will be started by the slave.

I²C bus operates with 8-bit data frame. Information from the sensor to the master has a checksum after every second 8-bit data frame. Humidity and temperature data will always be transmitted in the following way: The first value is the temperature signal (2 * 8-bit data + 8-bit CRC), the second is the humidity signal (2 * 8-bit data + 8-bit CRC). The checksum (CRC) property is listed on the table below.

Table 5 Data Checksum Properties

Item	Symbol
Type	CRC-8
Data Length	16-bit
Polynomial	$0x31(X^8+X^5+X^4+1)$
Initial Value	0xFF
Reflect Input/Output	False/False
Final XOR	0x00
Example	CRC(0xBEEF) = 0x92

9.4 Command

Below table is the command instruction of GW8245/46/47/48.

Table 6 Instructions for Function Commands

Command (HEX)	Return # (Bytes)	Description
0xFD	6	Measure T & RH with High Repeatability (High Precision) [2-byte T data + 1-byte CRC + 2-byte RH data + 1-byte CRC]
0xF6	6	Measure T & RH with Medium Repeatability (Medium Precision) [2-byte T data + 1-byte CRC + 2-byte RH data + 1-byte CRC]
0xE0	6	Measure T & RH with Low Repeatability (Lowest Precision) [2-byte T data + 1-byte CRC + 2-byte RH data + 1-byte CRC]
0x89	6	Read Serial Number [2-byte serial number data + 1-byte CRC + 2-byte serial number data + 1-byte CRC]
0x94	-	Soft Reset [ACK]
0x39	6	Activate Heater with 200mW power for 1s, Including High Precision Measurement just before Deactivation [2-byte T data + 1-byte CRC + 2-byte RH data + 1-byte CRC]
0x32	6	Activate Heater with 200mW power for 0.1s, Including High Precision Measurement just before Deactivation [2-byte T data + 1-byte CRC + 2-byte RH data + 1-byte CRC]
0x2F	6	Activate Heater with 110mW power for 1s, Including High Precision Measurement just before Deactivation [2-byte T data + 1-byte CRC + 2-byte RH data + 1-byte CRC]
0x24	6	Activate Heater with 110mW power for 0.1s, Including High Precision Measurement just before Deactivation [2-byte T data + 1-byte CRC + 2-byte RH data + 1-byte CRC]
0x1E	6	Activate Heater with 20mW power for 1s, Including High Precision Measurement just before Deactivation [2-byte T data + 1-byte CRC + 2-byte RH data + 1-byte CRC]
0x15	6	Activate Heater with 20mW power for 0.1s, Including High Precision Measurement just before Deactivation [2-byte T data + 1-byte CRC + 2-byte RH data + 1-byte CRC]

Note: If the sensor is not ready to process a command, e.g. busy to measure, the response will be NACK on I²C read header. Given heater power values are typical and valid for VDD = 3.3V

9.5 Measurement Conversion

The relation between sensor signals and relative humidity and temperature values are as below:

$$\text{RH} = \left(-6 + 125 \cdot \frac{S_{\text{RH}}}{2^{16}-1}\right) \% \text{RH} \quad (1)$$

$$T = \left(-45 + 175 \cdot \frac{S_{\text{T}}}{2^{16}-1}\right) ^\circ \text{C} \quad (2)$$

$$T = \left(-49 + 315 \cdot \frac{S_{\text{T}}}{2^{16}-1}\right) ^\circ \text{F} \quad (3)$$

The RH conversion formula (1) allows values to be reported which are outside of the range of 0%RH to 100%RH. Relative humidity values which are smaller than 0%RH and larger than 100%RH are non-physical, however, these “uncropped” values might be found beneficial in some cases (e.g. when the distribution of the sensors at the measurement boundaries are of interest). For all users who do not want to engage in evaluation of these non-physical values, cropping of the RH signal to the range of 0%RH to 100%RH is advised.

9.6 Serial Number

Each of the GW8245/46/47/48 has a unique serial number, that is assigned with specific rules during production. It is stored in the OTP (one-time-programmable) memory and cannot be manipulated after production. The serial number is accessible via I²C command 0x89 and is transmitted as two 16-bit words, each followed by an 8-bit CRC.

9.7 Reset & Abort

A reset of the GW8245/46/47/48 can be achieved in three ways:

1. Soft reset: send the reset command described in Table 6.
2. I²C general call reset: all devices on I²C bus are reset by sending the command 0x06 to the I²C address 0x00.
3. Power down (incl. pulling SCL and SDA low).

Any command that triggers an action at the sensor can be aborted via I²C general call reset or soft reset.

9.8 Heater

The sensor incorporates an integrated on-chip heater which can be switched on by the set of different commands given in Table 6. Three heating powers and two heating durations are selectable. After reception of a heater-on command, the sensor executes the following procedure:

1. The heater is enabled, and the timer starts count-down
2. On timer expiration a temperature and relative humidity measurement with the highest repeatability is started, the heater remains enabled
3. After the measurement is finished the heater is turned off
4. Temperature and relative humidity values are now available for readout

The maximum on time of the heater commands is one second in order to prevent overheating of the sensor by unintended usage of the heater. In cases where periodic heating is required, it is necessary to ensure

that the duty cycle of the heater's on and off times is less than 10%.

Possible Heater Use Cases:

1. Removal of condensed / spray water on the sensor surface. Although condensed water is not a reliability / quality problem to the sensor, it will however make the sensor non-responsive to RH changes in the air as long as there is liquid water on the surface.
2. Creep-free operation in high humid environments. Periodic heating pulses allow for creep-free high-humidity measurements for extended times.

Important notes for operating the heater:

1. The heater is designed for a maximum duty cycle of 10%, meaning the total heater-on-time should not be longer than 10% of the sensor's lifetime.
2. During operation of the heater, sensor specifications are not valid.
3. The temperature sensor can additionally be affected by the thermally induced mechanical stress, offsetting the temperature reading from the actual temperature.
4. The sensor's temperature (base temperature + temperature increase from heater) must not exceed $T_{MAX} = 125\text{ °C}$ in order to have proper electrical functionality of the chip.
5. The heater draws a large amount of current once enabled (up to 70 mA in the highest power setting). Although a dedicated circuitry draws this current smoothly, the power supply must be strong enough to avoid large voltage drops that could provoke a sensor reset.
6. If higher heating temperatures are desired, consecutive heating commands must be sent to the sensor. The heater shall only be operated in ambient temperatures below 65 °C or else it could drive the sensor outside of its maximal operating temperature (125°C).

10 Package Information

10.1 DFN-4 Package Outline (1.5mm X 1.5mm)

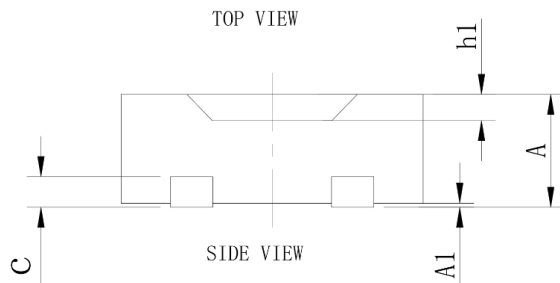
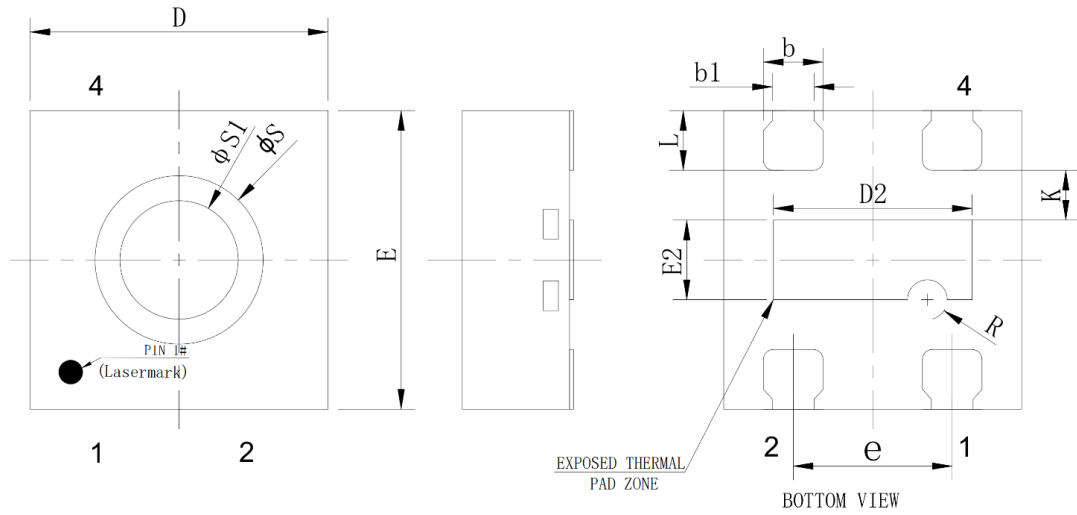

SYMBOL	MILLIMETER		
	MIN	NOM	MAX
A	0.49	0.54	0.59
A1	0	0.02	0.05
b	0.25	0.30	0.35
b1	0.21REF		
c	0.152REF		
D	1.45	1.50	1.55
D2	0.90	1.00	1.10
E	1.45	1.50	1.55
E2	0.30	0.40	0.50
e	0.80BSC		
K	0.25REF		
L	0.25	0.30	0.35
R	0.10REF		
ϕS	0.846BSC △		
$\phi S1$	0.595BSC △		
h1	0.08	0.13	0.18

Figure 12 Dimensional Drawing (in mm)

10.2 Land Pattern

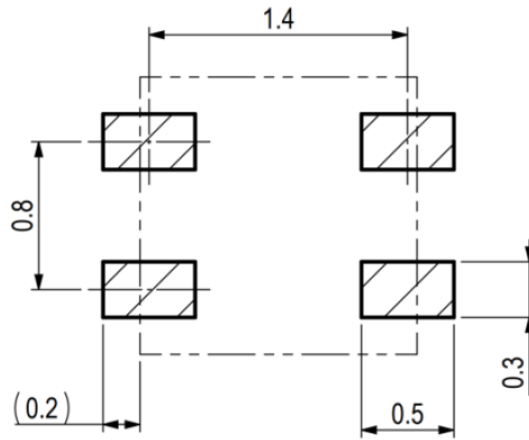
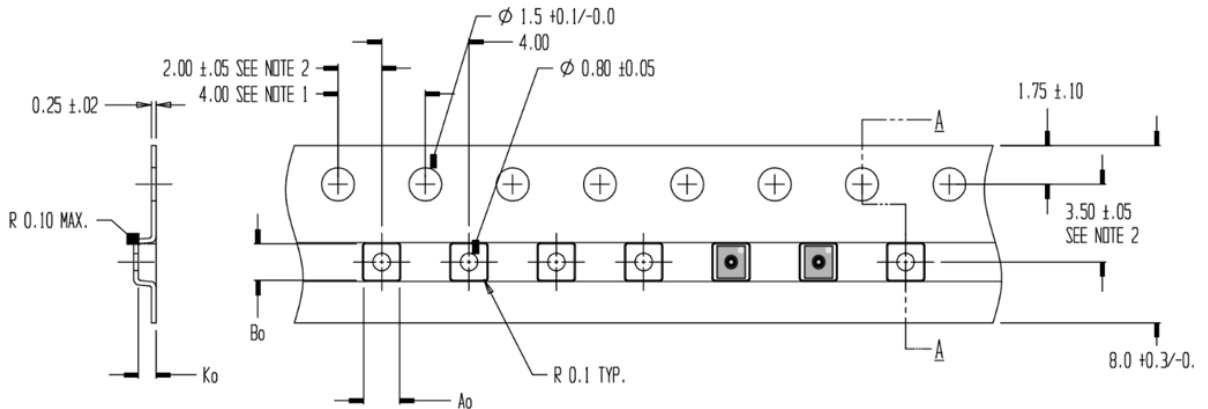

Figure 13 Recommended Land Pattern (in mm)

10.3 Tape and Reel Information



NOTES:

1. 10 SPROCKET HOLE PITCH CUMULATIVE TOLERANCE ± 0.2
2. POCKET POSITION RELATIVE TO SPROCKET HOLE MEASURED AS TRUE POSITION OF POCKET, NOT POCKET HOLE
3. A_0 AND B_0 ARE CALCULATED ON A PLANE AT A DISTANCE "R" ABOVE THE BOTTOM OF THE POCKET.

$A_0 = 1.65 \pm 0.05$
 $B_0 = 1.65 \pm 0.05$
 $K_0 = 0.81 \pm 0.05$

TOLERANCES - UNLESS NOTED 1PL ± 0.2 2PL ± 0.10

Note: The diameter of the reel for the single-disc 10K is 13 inches, and that for the 2.5K is 8 inches

Figure 14 Tape and Reel Information

Notice

3. The descriptions of circuits, software, and other related information in this document are solely meant to demonstrate how semiconductor products operate and provide examples of their applications. You hold complete responsibility for incorporating or using the circuits, software, and information in designing your own product or system.
4. Gwanak Analog takes no responsibility for any losses or damages suffered by you or third parties resulting from the utilization of these circuits, software, or information.
5. Gwanak Analog explicitly disclaims any responsibility or liability for infringement or any other claims related to patents, copyrights, or other intellectual property rights of third parties, resulting from the use of Gwanak Analog products or technical information described in this document. This includes, but is not limited to, product data, drawings, charts, programs, algorithms, and application examples.
6. This document does not grant any form of license, whether explicit, implicit, or otherwise, under any patents, copyrights, or other intellectual property rights owned by Gwanak Analog or any other party.
7. It is your responsibility to identify and obtain any necessary licenses from third parties for the legal import, export, manufacturing, sales, use, distribution, or any other actions involving products that incorporate Gwanak Analog products, if such licenses are required.
8. You are prohibited from making any changes, modifications, copies, or reverse engineering of Gwanak Analog products, whether partially or entirely. Gwanak Analog takes no responsibility for any losses or damages suffered by you or third parties resulting from such actions of alteration, modification, copying, or reverse engineering.
9. No semiconductor product can guarantee absolute security. Despite any security measures or features incorporated into Gwanak Analog hardware or software products, Gwanak Analog holds no liability for any vulnerabilities or security breaches, including unauthorized access or usage of Gwanak Analog products or systems utilizing them. Gwanak Analog does not provide assurance or guarantee that Gwanak Analog products or systems created with them will be immune to issues like corruption, attacks, viruses, interference, hacking, data loss or theft, or other security intrusions. Gwanak Analog disclaims all responsibility and liability associated with vulnerability issues. Additionally, to the extent permitted by applicable law, Gwanak Analog disclaims all warranties, whether expressed or implied, regarding this document and any related software or hardware, including but not limited to warranties of merchantability or fitness for a particular purpose.
10. While Gwanak Analog strives to enhance the quality and reliability of its products, semiconductor products possess inherent characteristics, such as a certain failure rate and potential malfunctions under specific usage conditions. Unless explicitly specified as high-reliability products or intended for harsh environments in Gwanak Analog data sheets or other official documents, Gwanak Analog products do not incorporate radiation-resistant design. It is your responsibility to implement safety precautions to mitigate the risk of bodily harm, injuries, damage, or public hazards resulting from failures or malfunctions of Gwanak Analog products. These safety measures may include hardware and software safety design, such as redundancy, fire control, malfunction prevention, appropriate measures to address aging degradation, or other suitable actions. Since evaluating microcomputer software independently is challenging and impractical, you are accountable for assessing the safety of the final products or systems manufactured by you.
11. For specific information regarding environmental concerns related to Gwanak Analog products, kindly get in touch with a Gwanak Analog sales office. It is your responsibility to conduct a thorough investigation and ensure compliance with relevant laws and regulations pertaining to the usage or inclusion of controlled substances, including but not limited to the EU RoHS Directive. Gwanak Analog takes no responsibility for any damages or losses incurred due to your failure to comply with applicable laws and regulations.
12. Gwanak Analog products and technologies must not be utilized or included in any products or systems that are prohibited by domestic or foreign laws or regulations. You are required to adhere to export control laws and regulations imposed by governments of countries that assert jurisdiction over the parties involved or the transactions taking place.
13. The buyer, distributor, or any party involved in the distribution, sale, or transfer of Gwanak Analog products to a third party is responsible for informing the third party in advance about the contents and conditions specified in this document.
14. The content of this document cannot be reproduced, copied, or duplicated, either fully or partially, without obtaining prior written consent from Gwanak Analog.
15. If you have any inquiries about the information provided in this document or Gwanak Analog products, please reach out to a Gwanak Analog sales office for assistance.

Corporate Headquarters

Gwanak Analog Co., Ltd., 1 Gwanak-ro, Gwanak-gu,
Seoul National University Research Park, FL 5, Seoul,
Korea 08826

Contact Information

For further information on a product, technology, the
most up-to-date version of a document, or your nearest
sales office, please visit:
www.gwanakanalog.com

Trademarks

Gwanak Analog and Gwanak Analog logo are trademarks
of Gwanak Analog Company. All trademarks and
registered trademarks are the property of their
respective owners.